

Truh.pl

Table of contents:

- Daihatsu Feroza
- Hyundai Terracan
- Isuzu Trooper, D-MAX, Opel Frontera, Monterey
- Mitsubishi Pajero II, Pajero Sport I, L200
- Mitsubishi Pajero III, Pajero IV, L200/Triton
- Nissan Terrano, Pick UP, Ford Maverick
- Nissan Patrol Y60, Patrol Y61
- Ford Ranger, Mazda BT-50
- Mitsubishi Delica L200, L300
- Ssangyong Korando, Musso, Daewoo Korando, Musso
- Hyundai Galloper
- Wheel flange spacers

Comments:

The quoted prices include tax.

We determine the shipping cost after the customer gives us the address and preferred delivery method.

Daihatsu Feroza

<p>Upper ball joint spacers 20mm Daihatsu Feroza DWDF_20mm</p>	
<p>Euro 64,99</p>	

<p>Upper ball joint spacers 20mm Daihatsu Feroza + camber correction shims DWDF_BLZS_20mm</p>	
<p>Euro 74,99</p>	

Hyundai Terracan

<p>Body lift +1" Hyundai Terracan BLHT-1C-Poliamid</p>	
<p>Euro 102,99</p>	

<p>Body lift +2" Hyundai Terracan BLHT-2C-Poliamid</p>	
<p>Euro 114,99</p>	

<p>Body lift +3" Hyundai Terracan BLHT-3C-Poliamid</p>	
<p>Euro 139,99</p>	

<p>Body lift stepped Hyundai Terracan BL_S_HT</p>	
<p>Euro 139,99</p>	

<p>Winch mounting plate Hyundai Terracan OP-6mm_HT</p>	
<p>Euro 229,99</p>	

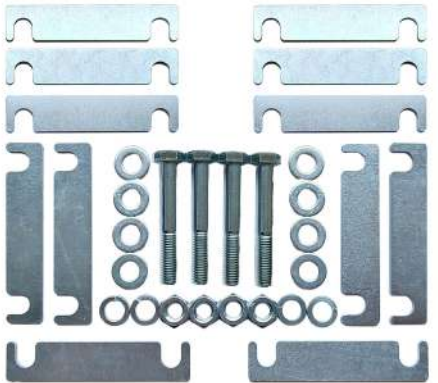
<p>Extended set of camber correction shims Hyundai Terracan</p>	
<p>Euro 22,99</p>	

Body lift thermostat base +2 inch
Hyundai Terracan
PTTer

Euro
34,99



Rear shaft flange spacer Hyundai Terracan
FW_HT

Euro
39,99



Upper ball joint spacers Hyundai Terracan
20mm + camber correction shims
DWHT_BLZS_20mm

Euro
62,99



Upper ball joint spacers Hyundai Terracan
20mm + camber correction shims + ball joints
DWHT_BLZS_SW_20mm



Euro
109,99

Upper ball joint spacers Hyundai Terracan
30mm + camber correction shims
DWHT_BLZS_30mm

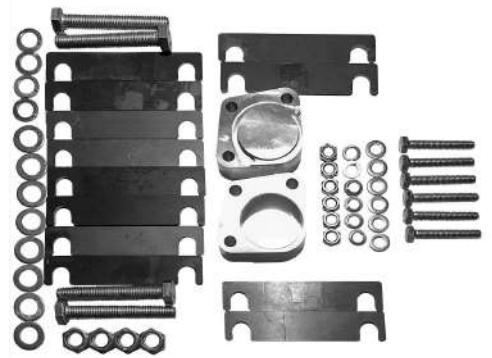

Euro
81,99

Upper ball joint spacers Hyundai Terracan
30mm + camber correction shims + ball joints
DWHT_BLZS_SW_30mm





Euro
129,99

Isuzu Trooper, D-MAX, Opel Frontera, Monterey

<p>Basic set of camber correction shims Isuzu Trooper, D-MAX, Opel Frontera, Monterey</p>	
<p>Euro 11,99</p>	

<p>Body lift +1" Opel Frontera BLOF-1C-3D-Poliamid</p>	
<p>Euro 91,99</p>	

<p>Body lift +2" Opel Frontera BLOF-2C-3D-Poliamid</p>	
<p>Euro 102,99</p>	

<p>Body lift +3" Opel Frontera BLOF-3C-3D-Poliamid</p>	
<p>Euro 124,99</p>	

<p>Body lift +1" Opel Frontera BLOF-1C-5D-Poliamid</p>	
<p>Euro 102,99</p>	

<p>Body lift +2" Opel Frontera BLOF-2C-5D-Poliamid</p>	
<p>Euro 114,99</p>	

<p>Body lift +3" Opel Frontera BLOF-3C-5D-Poliamid</p>	
<p>Euro 139,99</p>	

<p>Body lift +2" Opel Frontera BLOF-2C-5D-12-Poliamid</p>	
<p>Euro 124,99</p>	

<p>Upper ball joint spacers 10mm Isuzu Trooper, D-MAX, Opel Frontera, Monterey DWIT_10mm</p>	
<p>Euro 34,99</p>	

Upper ball joint spacers 10mm Isuzu Trooper, D-MAX,
Opel Frontera, Monterey + camber correction shims
DWIT_BLZS_10mm

Euro
42,99

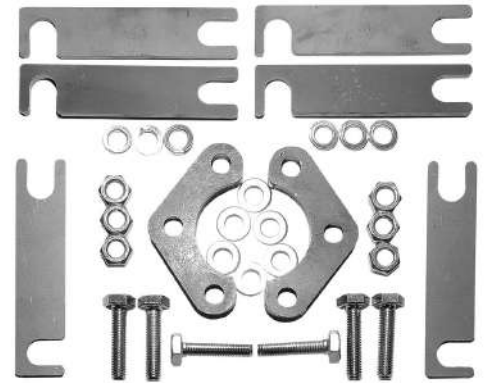

Upper ball joint spacers 10mm Isuzu Trooper, D-MAX,
Opel Frontera, Monterey + ball joints
DWIT_SW_10mm

Euro
64,99



Upper ball joint spacers 10mm Isuzu Trooper, D-MAX,
Opel Frontera, Monterey
+ ball joints + camber correction shims
DWIT_SW_BLZS_10mm

Euro
72,99

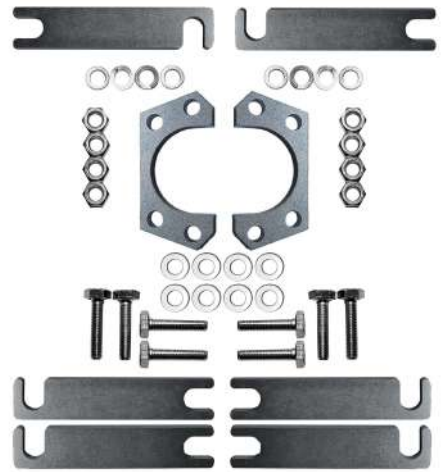

<p>Upper ball joint spacers 10mm Isuzu Trooper I, D-MAX, Opel Campo, Frontera, Monterey + camber correction shims DWIT-4S_BLZS_10mm-S</p>	
<p>Euro 42,99</p>	

<p>Upper ball joint spacers 10mm Isuzu Trooper I, D-MAX, Opel Campo, Frontera, Monterey + ball joints + camber correction shims DWIT-4S_SW_BLZS_10mm-S</p>	
<p>Euro 72,99</p>	

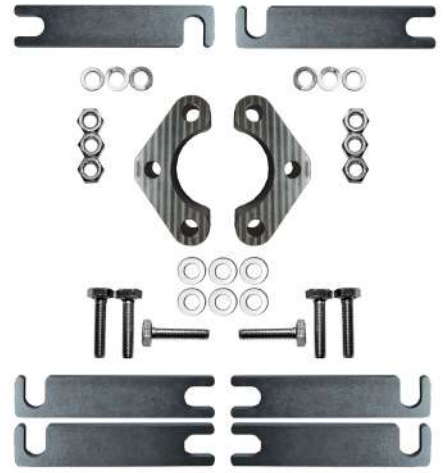
<p>Upper ball joint spacers 20mm Isuzu Trooper II, D-MAX, Opel Frontera, Monterey + camber correction shims DWIT-3S_BLZS_20mm</p>	
<p>Euro 58,99</p>	

Upper ball joint spacers 20mm Isuzu Trooper II, D-MAX,
Opel Frontera, Monterey + ball joints + camber correction
shims
DWIT-3S_SW_BLZS_20mm

Euro
88,99



Upper ball joint spacers 20mm Isuzu Trooper I, D-MAX,
Opel Campo Frontera, Monterey + camber correction
shims
DWIT-4S_BLZS_20mm

Euro
58,99

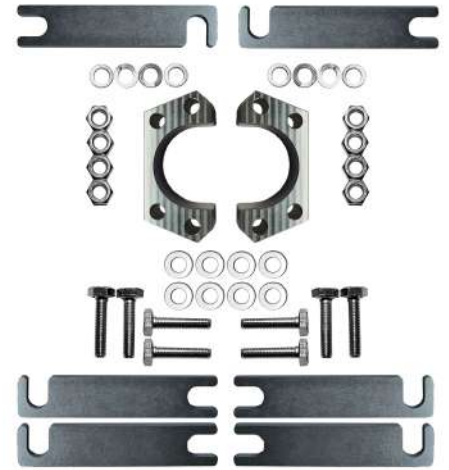

Upper ball joint spacers 20mm Isuzu Trooper II, D-MAX,
Opel Frontera, Monterey + ball joints + camber correction
shims
DWIT-4S_SW_BLZS_20mm

Euro
88,99

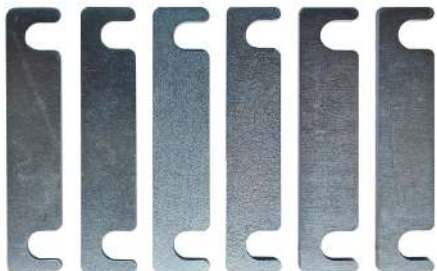

Mitsubishi Pajero II, Pajero Sport I, L200

<p>Basic set of camber correction shims Mitsubishi Pajero II, Pajero Sport I, L200</p>	
<p>Euro 12,99</p>	

<p>Extended set of camber correction shims Mitsubishi Pajero II, Pajero Sport I, L200</p>	
<p>Euro 23,99</p>	

<p>Body lift +1" Mitsubishi Pajero II, Pajero Sport I BL-1C-3D-Poliamid</p>	
<p>Euro 91,99</p>	

Body lift +1" Mitsubishi Pajero II, Pajero Sport I
BL-1C-5D-Poliamid

Euro
102,99



Body lift +1" Mitsubishi Pajero II
BL-1C-5D-12-Poliamid

Euro
114,99



Body lift +2" Mitsubishi Pajero II, Pajero Sport I
BL-2C-3D-Poliamid

Euro
102,99



Body lift +2" Mitsubishi Pajero II, Pajero Sport I
BL-2C-5D-Poliamid

Euro
114,99



Body lift +2" Mitsubishi Pajero II
BL-2C-5D-12-Poliamid

Euro
124,99



Body lift +2" Mitsubishi L200
BLML200-2C-PLM

Euro
142,99

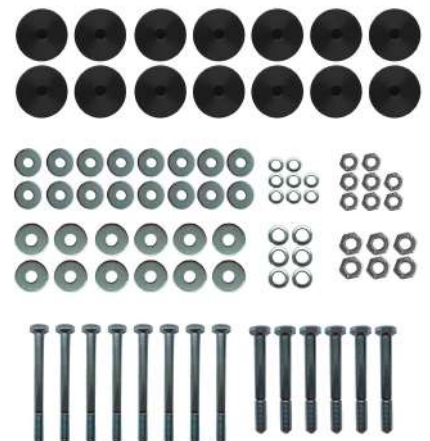

<p>Body lift +3" Mitsubishi Pajero II, Pajero Sport I BL-3C-3D-Poliamid</p>	
<p>Euro 124,99</p>	

<p>Body lift +3" Mitsubishi Pajero II, Pajero Sport I BL-3C-5D-Poliamid</p>	
<p>Euro 139,99</p>	

<p>Upper ball joint spacers 20mm Mitsubishi Pajero II, Pajero Sport I, L200 + camber correction shims DWMP_BLZS_20mm</p>	
<p>Euro 62,99</p>	

<p>Upper ball joint spacers 20mm Mitsubishi Pajero II, Pajero Sport I, L200 + ball joints + camber correction shims DWMP_SW_BLZS_20mm</p>	
<p>Euro 88,99</p>	

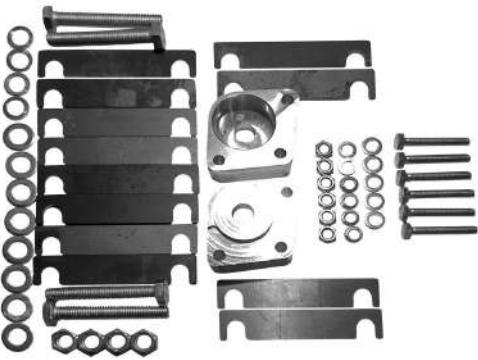
<p>Upper ball joint spacers 30mm Mitsubishi Pajero II, Pajero Sport I, L200 + camber correction shims DWMP_BLZS_30mm</p>	
<p>Euro 81,99</p>	

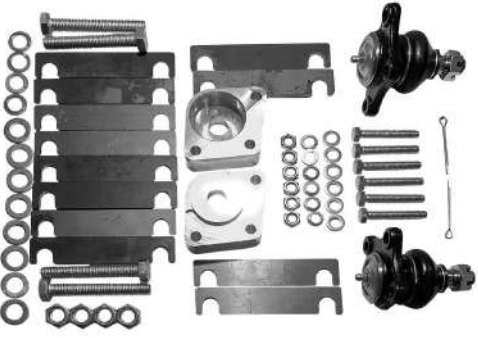
<p>Upper ball joint spacers 30mm Mitsubishi Pajero II, Pajero Sport I, L200 + ball joints + camber correction shims DWMP_SW_BLZS_30mm</p>	
<p>Euro 104,99</p>	

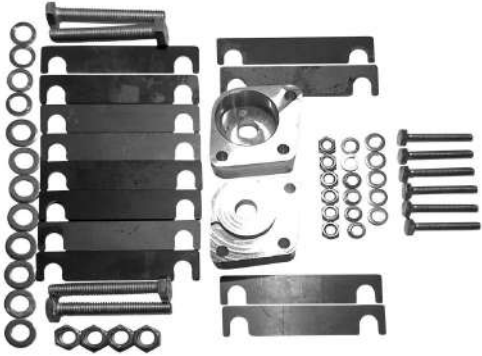
<p>Upper ball joint spacers 40mm Mitsubishi Pajero II, Pajero Sport I, L200 + camber correction shims DWMP_BLZS_40mm</p>	
<p>Euro 91,99</p>	

<p>Upper ball joint spacers 40mm Mitsubishi Pajero II, Pajero Sport I, L200 + ball joints + camber correction shims DWMP_SW_BLZS_40mm</p>	
<p>Euro 114,99</p>	

<p>Upper ball joint spacers 50mm Mitsubishi Pajero II, Pajero Sport I, L200 + camber correction shims DWMP_BLZS_50mm</p>	
<p>Euro 104,99</p>	

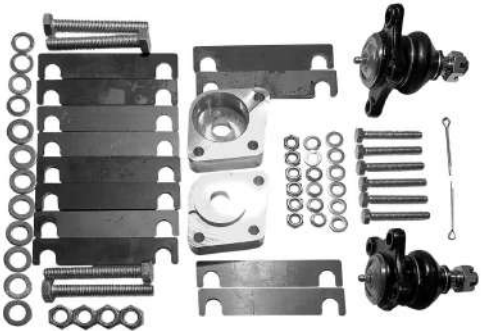
<p>Upper ball joint spacers 50mm Mitsubishi Pajero II, Pajero Sport I, L200 + ball joints + camber correction shims DWMP_SW_BLZS_50mm</p>	
<p>Euro 126,99</p>	

Mitsubishi Pajero III, Pajero IV, L200/Triton

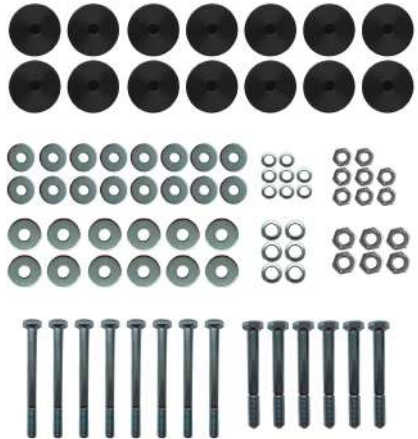
<p>Body lift +2" Mitsubishi L200/Triton BLML200-2C-PLM</p>	
<p>Euro 142,99</p>	

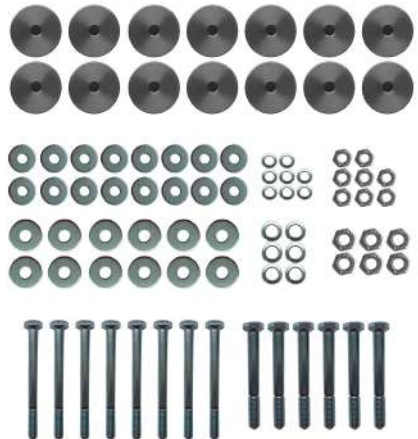
<p>Body lift +2" Mitsubishi L200/Triton BLML200-2C-Alu</p>	
<p>Euro 179,99</p>	

Winch mounting plate
Mitsubishi Pajero III, Pajero IV

Euro
204,99



Upper ball joint spacers 20mm Mitsubishi Pajero III,
Pajero IV, L200/Triton
DWMPIII_20mm

Euro
49,99





Upper ball joint spacers 20mm Mitsubishi Pajero III,
Pajero IV, L200/Triton + ball joints
DWMPIII_SW_20mm

Euro
79,99



<p>Upper ball joint spacers 30mm Mitsubishi Pajero III, Pajero IV, L200/Triton DWMPIII_30mm</p>	
<p>Euro 62,99</p>	

<p>Upper ball joint spacers 30mm Mitsubishi Pajero III, Pajero IV, L200/Triton + ball joints DWMPIII_SW_30mm</p>	
<p>Euro 88,99</p>	

<p>Rear control arm spacer 20mm Mitsubishi Pajero III, Pajero IV DWTTMIII_20mm</p>	
<p>Euro 49,99</p>	

<p>Rear control arm spacer 30mm Mitsubishi Pajero III, Pajero IV DWTTMPIII_30mm</p>	 <p>A collection of metal parts for a rear control arm spacer kit. It includes two large triangular spacers with mounting holes, two smaller triangular spacers, two sets of four nuts, two sets of four washers, and six bolts of varying lengths.</p>
<p>Euro 86,99</p>	

Nissan Terrano, Pick UP, Ford Maverick

<p>Basic set of camber correction shims Nissan Terrano, Ford Maverick</p>	 <p>A set of six black metal camber correction shims. Each shim has a curved top edge and a notched bottom edge.</p>
<p>Euro 13,99</p>	

<p>Body lift +1" Nissan Terrano BLNT-1C-3D-Poliamid</p>	 <p>A body lift kit for a Nissan Terrano. It includes four black polyamide spacers, a set of four nuts and washers, a set of four bolts, and a set of four longer bolts.</p>
<p>Euro 91,99</p>	

<p>Body lift +2" Nissan Terrano BLNT-2C-3D-Poliamid</p>	
<p>Euro 102,99</p>	

<p>Body lift +3" Nissan Terrano BLNT-3C-3D-Poliamid</p>	
<p>Euro 124,99</p>	

<p>Body lift +1" Nissan Terrano BLNT-1C-5D-Poliamid</p>	
<p>Euro 102,99</p>	

<p>Body lift +2" Nissan Terrano BLNT-2C-5D-Poliamid</p>	
<p>Euro 114,99</p>	

<p>Body lift +3" Nissan Terrano BLNT-3C-5D-Poliamid</p>	
<p>Euro 139,99</p>	

<p>Upper ball joint spacers 10mm Nissan Terrano, Pick Up, Ford Maverick DWNT_10mm</p>	
<p>Euro 34,99</p>	

Upper ball joint spacers 10mm Nissan Terrano, Pick Up,
Ford Maverick + camber correction shims
DWNT_BLZS_10mm

Euro
45,99



Upper ball joint spacers 10mm Nissan Terrano, Pick Up,
Ford Maverick + ball joints
DWNT_SW_10mm

Euro
64,99



Upper ball joint spacers 10mm Nissan Terrano, Pick Up,
Ford Maverick + ball joints + camber correction shims
DWNT_SW_BLZS_10mm

Euro
77,99



<p>Upper ball joint spacers 30mm Nissan Terrano, Pick Up, Ford Maverick DWNT_30mm</p>	
<p>Euro 64,99</p>	

<p>Upper ball joint spacers 30mm Nissan Terrano, Pick Up, Ford Maverick + camber correction shims DWNT_BLZS_30mm</p>	
<p>Euro 77,99</p>	

<p>Upper ball joint spacers 30mm Nissan Terrano, Pick Up, Ford Maverick + ball joints DWNT_SW_30mm</p>	
<p>Euro 91,99</p>	

<p>Upper ball joint spacers 30mm Nissan Terrano, Pick Up, Ford Maverick + ball joints + camber correction shims DWNT_SW_BLZS_30mm</p>	
<p>Euro 104,99</p>	

Nissan Patrol Y60, Patrol Y61

<p>Body lift +1" Nissan Patrol BLNP-1C-3D-Poliamid</p>	
<p>Euro 91,99</p>	

<p>Body lift +1" Nissan Patrol BLNP-1C-5D-Poliamid</p>	
<p>Euro 102,99</p>	

<p>Body lift +2" Nissan Patrol BLNP-2C-3D-Poliamid</p>	
<p>Euro 102,99</p>	

<p>Body lift +3" Nissan Patrol BLNP-3C-3D-Poliamid</p>	
<p>Euro 124,99</p>	

<p>Body lift +2" Nissan Patrol BLNP-2C-5D-Poliamid</p>	
<p>Euro 114,99</p>	

<p>Body lift +3" Nissan Patrol BLNP-3C-5D-Poliamid</p>	
<p>Euro 139,99</p>	

Ford Ranger, Mazda BT-50

<p>Basic set of wheel angle camber correction shims - galvanized Ford Ranger</p>	
<p>Euro 13,99</p>	

<p>Upper ball joint spacers 15mm Ford Ranger, Mazda BT-50 DWFR_15mm</p>	
<p>Euro 45,99</p>	

<p>Upper ball joint spacers 15mm Ford Ranger, Mazda BT-50 + camber correction shims DWFR_BLZS_15mm</p>	
<p>Euro 58,99</p>	

<p>Upper ball joint spacers 15mm Ford Ranger, Mazda BT-50 + ball joints DWFR_SW_15mm</p>	
<p>Euro 76,99</p>	

<p>Upper ball joint spacers 15mm Ford Ranger, Mazda BT-50 + ball joints + camber correction shims DWFR_SW_BLZS_15mm</p>	
<p>Euro 88,99</p>	

<p>Upper ball joint spacers 25mm Ford Ranger, Mazda BT-50 DWFR_25mm</p>	
<p>Euro 49,99</p>	

<p>Upper ball joint spacers 25mm Ford Ranger, Mazda BT-50 + camber correction shims DWFR_BLZS_25mm</p>	
<p>Euro 64,99</p>	

<p>Upper ball joint spacers 25mm Ford Ranger, Mazda BT-50 + ball joints DWFR_SW_25mm</p>	
<p>Euro 79,99</p>	

<p>Upper ball joint spacers 25mm Ford Ranger, Mazda BT-50 + ball joints + camber correction shims DWFR_SW_BLZS_25mm</p>	
<p>Euro 93,99</p>	

Mitsubishi Delica L300, L400

<p>Upper ball joint spacers 25mm Mitsubishi Delica DWDE_25mm</p>	
<p>Euro 49,99</p>	

<p>Upper ball joint spacers 25mm Mitsubishi Delica + ball joints DWDE_SW_25mm</p>	
<p>Euro 79,99</p>	

Ssangyong Korando, Musso, Daewoo Korando, Musso

<p>Upper ball joint spacers 20mm Ssangyong Korando, Musso, Daewoo Korando, Musso DWSD-4_20mm</p>	 A kit of upper ball joint spacers. It includes two large, dark-colored metal spacers with a central circular cutout. Surrounding the spacers are various hardware: two sets of three nuts and washers, two sets of three bolts, and two sets of three longer bolts with washers.
<p>Euro 49,99</p>	

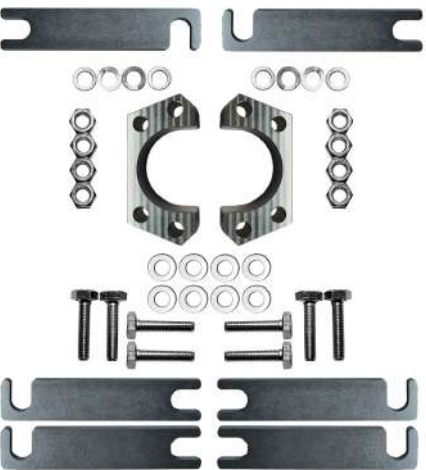
<p>Upper ball joint spacers 20mm Ssangyong Korando, Musso, Daewoo Korando, Musso + camber correction shims DWSD-4_BLZS_20mm</p>	 A kit of upper ball joint spacers and camber correction shims. It includes two large metal spacers, two sets of three nuts and washers, two sets of three bolts, and two sets of three longer bolts with washers. Additionally, there are two sets of three camber correction shims, which are thin metal plates with a U-shaped notch.
<p>Euro 62,99</p>	

<p>Upper ball joint spacers 20mm Ssangyong Korando, Musso, Daewoo Korando, Musso + ball joints DWSD-4_SW_20mm</p>	 A kit of upper ball joint spacers and ball joints. It includes two large metal spacers, two sets of three nuts and washers, two sets of three bolts, and two sets of three longer bolts with washers. Additionally, there are two ball joints, which are cylindrical components with a ball joint end and a mounting bracket end.
<p>Euro 77,99</p>	

<p>Upper ball joint spacers 20mm Ssangyong Korando, Musso, Daewoo Korando, Musso + ball joints + camber correction shims DWSD-4_SW_BLZS_20mm</p>	
<p>Euro 88,99</p>	

Hyundai Galloper

<p>Body lift +1" Hyundai Galloper BLHG-1C-3D-Poliamid</p>	
<p>Euro 91,99</p>	

<p>Body lift +2" Hyundai Galloper BLHG-2C-3D-Poliamid</p>	
<p>Euro 102,99</p>	

<p>Body lift +3" Hyundai Galloper BLHG-3C-3D-Poliamid</p>	
<p>Euro 124,99</p>	

<p>Body lift +1" Hyundai Galloper BLHG-1C-5D-Poliamid</p>	
<p>Euro 102,99</p>	

<p>Body lift +2" Hyundai Galloper BLHG-2C-5D-Poliamid</p>	
<p>Euro 114,99</p>	

<p>Body lift +3" Hyundai Galloper BLHG-3C-5D-Poliamid</p>	
<p>Euro 139,99</p>	

Wheel flange spacers

<p>Wheel flange spacers 2pcs 4x98 58,1mm 5mm Truh DFK-4x98-58,1-5-2</p>	
<p>Euro 18,90</p>	

For cars:

ALFA ROMEO: 145, 146, 155, 165, 33, 90, Alfasud, Alfetta, Arna, Giulietta, Mito, Sprint
FIAT: 500, Albea, Barchetta, Bravo, Cinquecento, Coupe, Doblo, Duna, Fiorino, Idea, Linea, Marea, Multipla, Palio, Panda, Punto, Qubo, Regata, Ritmo, Seicento, Siena, Stilo, Strada, Tempra, Tipo, Uno
LADA: Kalina, Priora, Samara
LANCIA: Dedra, Delta, Lybra, Musa, Thema, Ypsilon

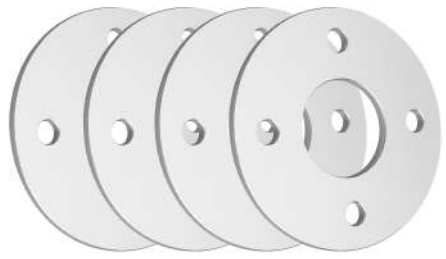
<p>Wheel flange spacers 4pcs 4x98 58,1mm 5mm Truh DFK-4x98-58,1-5-4</p>	
<p>Euro 36,90</p>	
<p style="text-align: center;">For cars:</p> <p>ALFA ROMEO: 145, 146, 155, 165, 33, 90, Alfasud, Alfetta, Arna, Giulietta, Mito, Sprint FIAT: 500, Albea, Barchetta, Bravo, Cinquecento, Coupe, Doblo, Duna, Fiorino, Idea, Linea, Marea, Multipla, Palio, Panda, Punto, Qubo, Regata, Ritmo, Seicento, Siena, Stilo, Strada, Tempra, Tipo, Uno ŁADA: Kalina, Priora, Samara LANCIA: Dedra, Delta, Lybra, Musa, Thema, Ypsilon</p>	

<p>Wheel flange spacers 2pcs 4x98 58,1mm 10mm Truh DFK-4x98-58,1-10-2</p>	
<p>Euro 20,90</p>	
<p style="text-align: center;">For cars:</p> <p>ALFA ROMEO: 145, 146, 155, 165, 33, 90, Alfasud, Alfetta, Arna, Giulietta, Mito, Sprint FIAT: 500, Albea, Barchetta, Bravo, Cinquecento, Coupe, Doblo, Duna, Fiorino, Idea, Linea, Marea, Multipla, Palio, Panda, Punto, Qubo, Regata, Ritmo, Seicento, Siena, Stilo, Strada, Tempra, Tipo, Uno ŁADA: Kalina, Priora, Samara LANCIA: Dedra, Delta, Lybra, Musa, Thema, Ypsilon</p>	

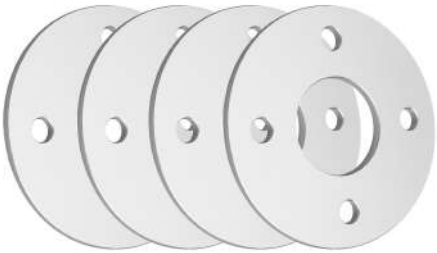
<p>Wheel flange spacers 4pcs 4x98 58,1mm 10mm Truh DFK-4x98-58,1-10-4</p>	
<p>Euro 40,90</p>	
<p style="text-align: center;">For cars:</p> <p>ALFA ROMEO: 145, 146, 155, 165, 33, 90, Alfasud, Alfetta, Arna, Giulietta, Mito, Sprint FIAT: 500, Albea, Barchetta, Bravo, Cinquecento, Coupe, Doblo, Duna, Fiorino, Idea, Linea, Marea, Multipla, Palio, Panda, Punto, Qubo, Regata, Ritmo, Seicento, Siena, Stilo, Strada, Tempra, Tipo, Uno ŁADA: Kalina, Priora, Samara LANCIA: Dedra, Delta, Lybra, Musa, Thema, Ypsilon</p>	

<p>Wheel flange spacers 2pcs 4x100 54,1mm 5mm Truh DFK-4x100-54,1-5-2</p>	
<p>Euro 18,90</p>	
<p style="text-align: center;">For cars:</p> <p>Citroen: C1 (2 generations). Daihatsu: Cuore, Materia, Mira Gino, Sirion (2 generations), Trevis, YRV. Hyundai: Accent (2 generations), Atos, Excel (2 generations), Getz, Getz Cross, i10 (2 generations), i20. Kia: Picanto (2 generations), Rio (3 generations). Mazda: 121, 2, 323 4 bolts, Demio, MX-3, MX-5. Opel / Vauxhall: Agila (2 generations), Ascona 6, Ascona C, Manta B. Peugeot: 107 Suzuki: Alto (2 generations), Alivio, Belem, Celerio, Esteem, Ignis (2 generations), Liana, Splash, Swift (3 generations), Wagon R plus. Toyota: Aygo, Celica (2 generations), Corolla (4 generations), Corolla Verso, IQ, MR2 (2</p>	

generations), Paseo, Prius, Starlet, Yaris (3 generations plus Yaris 17 inch), Yaris Verso.

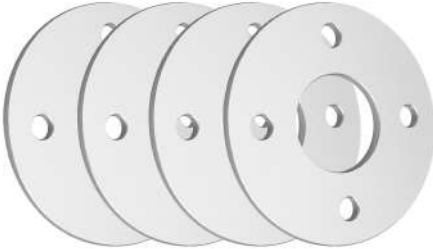
Wheel flange spacers 4pcs 4x100 54,1mm 5mm Truh DFK-4x100-54,1-5-4	
Euro 36,90	

For cars:
Citroen: C1 (2 generations).
Daihatsu: Cuore, Materia, Mira Gino, Sirion (2 generations), Trevis, YRV.
Hyundai: Accent (2 generations), Atos, Excel (2 generations), Getz, Getz Cross, i10 (2 generations), i20.
Kia: Picanto (2 generations), Rio (3 generations).
Mazda: 121, 2, 323 4 bolts, Demio, MX-3, MX-5.
Opel / Vauxhall: Agila (2 generations), Ascona 6, Ascona C, Manta B.
Peugeot: 107
Suzuki: Alto (2 generations), Alivio, Belem, Celerio, Esteem, Ignis (2 generations), Liana, Splash, Swift (3 generations), Wagon R plus.
Toyota: Aygo, Celica (2 generations), Corolla (4 generations), Corolla Verso, IQ, MR2 (2 generations), Paseo, Prius, Starlet, Yaris (3 generations plus Yaris 17 inch), Yaris Verso.

Wheel flange spacers 2pcs 4x100 54,1mm 10mm Truh DFK-4x100-54,1-10-2	
Euro 20,90	

For cars:
Citroen: C1 (2 generations).
Daihatsu: Cuore, Materia, Mira Gino, Sirion (2 generations), Trevis, YRV.

Hyundai: Accent (2 generations), Atos, Excel (2 generations), Getz, Getz Cross, i10 (2 generations), i20.

Kia: Picanto (2 generations), Rio (3 generations).

Mazda: 121, 2, 323 4 bolts, Demio, MX-3, MX-5.

Opel / Vauxhall: Agila (2 generations), Ascona 6, Ascona C, Manta B.

Peugeot: 107

Suzuki: Alto (2 generations), Alvivio, Belem, Celerio, Esteem, Ignis (2 generations), Liana, Splash, Swift (3 generations), Wagon R plus.

Toyota: Aygo, Celica (2 generations), Corolla (4 generations), Corolla Verso, IQ, MR2 (2 generations), Paseo, Prius, Starlet, Yaris (3 generations plus Yaris 17 inch), Yaris Verso.

Wheel flange spacers 4pcs 4x100 54,1mm 10mm Truh
DFK-4x100-54,1-10-4

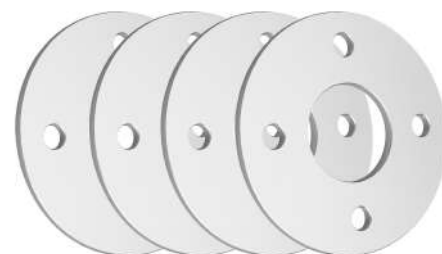

Euro
40,90

For cars:

Citroen: C1 (2 generations).

Daihatsu: Cuore, Materia, Mira Gino, Sirion (2 generations), Trevis, YRV.

Hyundai: Accent (2 generations), Atos, Excel (2 generations), Getz, Getz Cross, i10 (2 generations), i20.

Kia: Picanto (2 generations), Rio (3 generations).

Mazda: 121, 2, 323 4 bolts, Demio, MX-3, MX-5.

Opel / Vauxhall: Agila (2 generations), Ascona 6, Ascona C, Manta B.

Peugeot: 107

Suzuki: Alto (2 generations), Alvivio, Belem, Celerio, Esteem, Ignis (2 generations), Liana, Splash, Swift (3 generations), Wagon R plus.

Toyota: Aygo, Celica (2 generations), Corolla (4 generations), Corolla Verso, IQ, MR2 (2 generations), Paseo, Prius, Starlet, Yaris (3 generations plus Yaris 17 inch), Yaris Verso.

<p>Wheel flange spacers 2pcs 4x100 56,1mm 5mm Truh DFK-4x100-56,1-5-2</p>	
<p>Euro 18,90</p>	
<p style="text-align: center;">For cars:</p> <p>Daihatsu: Applause, Charade (Gen 3-4), Hijet / Porter (Van, Pickup), Move (Gen 1). Honda: Accord (Gen 2-3), Civic (Gen 1-7), Concerto, CR-X/CRX, CR-X del Sol (Gen 1-3), Insight (Gen 2), Integra (Gen 1-3), Jazz (Gen 1-3), Logo, Prelude (Gen 1-3), Quint. Kia: Sephia (2 generations), Shuma. MINI: One / Cooper / S / JCW (gen 1), One / Cooper / S / JCW (gen 2), Coupé / Roadster, Clubman / Clubman S (gen 1). Mitsubishi: Carisma 1.6 gasoline, Colt, i, i-MiEV, Lancer, Space Star. Rover: 200 Series (Mk1-Mk3), 25, 400 Series (Mk1-Mk2), 45, CityRover, Streetwise.</p>	

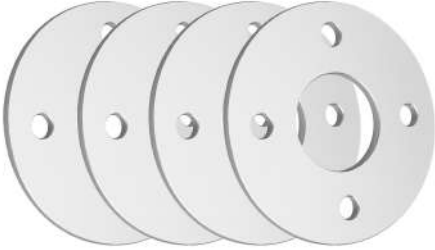
<p>Wheel flange spacers 4pcs 4x100 56,1mm 5mm Truh DFK-4x100-56,1-5-4</p>	
<p>Euro 36,90</p>	
<p style="text-align: center;">For cars:</p> <p>Daihatsu: Applause, Charade (Gen 3-4), Hijet / Porter (Van, Pickup), Move (Gen 1). Honda: Accord (Gen 2-3), Civic (Gen 1-7), Concerto, CR-X/CRX, CR-X del Sol (Gen 1-3), Insight (Gen 2), Integra (Gen 1-3), Jazz (Gen 1-3), Logo, Prelude (Gen 1-3), Quint. Kia: Sephia (2 generations), Shuma. MINI: One / Cooper / S / JCW (gen 1), One / Cooper / S / JCW (gen 2), Coupé / Roadster, Clubman / Clubman S (gen 1). Mitsubishi: Carisma 1.6 gasoline, Colt, i, i-MiEV, Lancer, Space Star. Rover: 200 Series (Mk1-Mk3), 25, 400 Series (Mk1-Mk2), 45, CityRover, Streetwise.</p>	

<p>Wheel flange spacers 2pcs 4x100 56,1mm 10mm Truh DFK-4x100-56,1-10-2</p>	
<p>Euro 20,90</p>	
<p style="text-align: center;">For cars:</p> <p>Daihatsu: Applause, Charade (Gen 3-4), Hijet / Porter (Van, Pickup), Move (Gen 1). Honda: Accord (Gen 2-3), Civic (Gen 1-7), Concerto, CR-X/CRX, CR-X del Sol (Gen 1-3), Insight (Gen 2), Integra (Gen 1-3), Jazz (Gen 1-3), Logo, Prelude (Gen 1-3), Quint. Kia: Sephia (2 generations), Shuma. MINI: One / Cooper / S / JCW (gen 1), One / Cooper / S / JCW (gen 2), Coupé / Roadster, Clubman / Clubman S (gen 1). Mitsubishi: Carisma 1.6 gasoline, Colt, i, i-MiEV, Lancer, Space Star. Rover: 200 Series (Mk1-Mk3), 25, 400 Series (Mk1-Mk2), 45, CityRover, Streetwise.</p>	

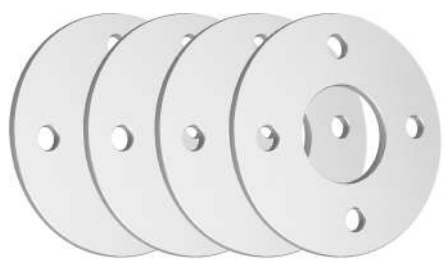
<p>Wheel flange spacers 4pcs 4x100 56,1mm 10mm Truh DFK-4x100-56,1-10-4</p>	
<p>Euro 40,90</p>	
<p style="text-align: center;">For cars:</p> <p>Daihatsu: Applause, Charade (Gen 3-4), Hijet / Porter (Van, Pickup), Move (Gen 1). Honda: Accord (Gen 2-3), Civic (Gen 1-7), Concerto, CR-X/CRX, CR-X del Sol (Gen 1-3), Insight (Gen 2), Integra (Gen 1-3), Jazz (Gen 1-3), Logo, Prelude (Gen 1-3), Quint. Kia: Sephia (2 generations), Shuma. MINI: One / Cooper / S / JCW (gen 1), One / Cooper / S / JCW (gen 2), Coupé / Roadster, Clubman / Clubman S (gen 1). Mitsubishi: Carisma 1.6 gasoline, Colt, i, i-MiEV, Lancer, Space Star. Rover: 200 Series (Mk1-Mk3), 25, 400 Series (Mk1-Mk2), 45, CityRover, Streetwise.</p>	

<p>Wheel flange spacers 2pcs 4x100 57,1mm 5mm Truh DFK-4x100-57,1-5-2</p>	
<p>Euro 18,90</p>	
<p>For cars: AUDI A2, BMW 3 E21, BMW 3 E30, OPEL Ascona A, OPEL Ascona B, OPEL Kadett C, OPEL Manta A, OPEL Rekord D, OPEL Rekord E, SEAT Arosa, SEAT Cordoba, SEAT Ibiza, SEAT Inca, SEAT Mii, SEAT Toledo, SKODA Citigo, SKODA Felicia, VW Caddy, VW Corrado, VW Golf I, VW Golf II, VW Golf III, VW Jetta, VW Lupo, VW Passat, VW Polo, VW Scirocco, VW Up, VW Vento</p>	

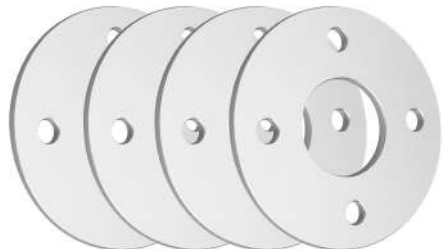
<p>Wheel flange spacers 4pcs 4x100 57,1mm 5mm Truh DFK-4x100-57,1-5-4</p>	
<p>Euro 36,90</p>	
<p>For cars: AUDI A2, BMW 3 E21, BMW 3 E30, OPEL Ascona A, OPEL Ascona B, OPEL Kadett C, OPEL Manta A, OPEL Rekord D, OPEL Rekord E, SEAT Arosa, SEAT Cordoba, SEAT Ibiza, SEAT Inca, SEAT Mii, SEAT Toledo, SKODA Citigo, SKODA Felicia, VW Caddy, VW Corrado, VW Golf I, VW Golf II, VW Golf III, VW Jetta, VW Lupo, VW Passat, VW Polo, VW Scirocco, VW Up, VW Vento</p>	

<p>Wheel flange spacers 2pcs 4x100 57,1mm 10mm Truh DFK-4x100-57,1-10-2</p>	
<p>Euro 20,90</p>	
<p>For cars: AUDI A2, BMW 3 E21, BMW 3 E30, OPEL Ascona A, OPEL Ascona B, OPEL Kadett C, OPEL Manta A, OPEL Rekord D, OPEL Rekord E, SEAT Arosa, SEAT Cordoba, SEAT Ibiza, SEAT Inca, SEAT Mii, SEAT Toledo, SKODA Citigo, SKODA Felicia, VW Caddy, VW Corrado, VW Golf I, VW Golf II, VW Golf III, VW Jetta, VW Lupo, VW Passat, VW Polo, VW Scirocco, VW Up, VW Vento</p>	

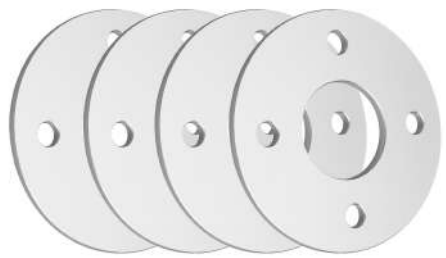
<p>Wheel flange spacers 4pcs 4x100 57,1mm 10mm Truh DFK-4x100-57,1-10-4</p>	
<p>Euro 40,90</p>	
<p>For cars: AUDI A2, BMW 3 E21, BMW 3 E30, OPEL Ascona A, OPEL Ascona B, OPEL Kadett C, OPEL Manta A, OPEL Rekord D, OPEL Rekord E, SEAT Arosa, SEAT Cordoba, SEAT Ibiza, SEAT Inca, SEAT Mii, SEAT Toledo, SKODA Citigo, SKODA Felicia, VW Caddy, VW Corrado, VW Golf I, VW Golf II, VW Golf III, VW Jetta, VW Lupo, VW Passat, VW Polo, VW Scirocco, VW Up, VW Vento</p>	

<p>Wheel flange spacers 2pcs 4x100 56,6mm 5mm Truh DFK-4x100-56,6-5-2</p>	
<p>Euro 18,90</p>	
<p>For cars: AUDI A2, BMW 3 E21, BMW 3 E30, OPEL Ascona A, OPEL Ascona B, OPEL Kadett C, OPEL Manta A, OPEL Rekord D, OPEL Rekord E, SEAT Arosa, SEAT Cordoba, SEAT Ibiza, SEAT Inca, SEAT Mii, SEAT Toledo, SKODA Citigo, SKODA Felicia, VW Caddy, VW Corrado, VW Golf I, VW Golf II, VW Golf III, VW Jetta, VW Lupo, VW Passat, VW Polo, VW Scirocco, VW Up, VW Vento</p>	

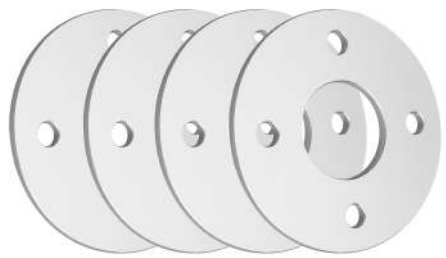
<p>Wheel flange spacers 4pcs 4x100 56,6mm 5mm Truh DFK-4x100-56,6-5-4</p>	
<p>Euro 36,90</p>	
<p>For cars: AUDI A2, BMW 3 E21, BMW 3 E30, OPEL Ascona A, OPEL Ascona B, OPEL Kadett C, OPEL Manta A, OPEL Rekord D, OPEL Rekord E, SEAT Arosa, SEAT Cordoba, SEAT Ibiza, SEAT Inca, SEAT Mii, SEAT Toledo, SKODA Citigo, SKODA Felicia, VW Caddy, VW Corrado, VW Golf I, VW Golf II, VW Golf III, VW Jetta, VW Lupo, VW Passat, VW Polo, VW Scirocco, VW Up, VW Vento</p>	

<p>Wheel flange spacers 2pcs 4x100 56,6mm 10mm Truh DFK-4x100-56,6-10-2</p>	
<p>Euro 20,90</p>	
<p>For cars: OPEL Adam, OPEL Astra F, OPEL Astra G, OPEL Astra H, OPEL Calibra, OPEL Combo, OPEL Corsa B, OPEL Corsa C, OPEL Corsa D, OPEL Corsa E, OPEL Kadet E, OPEL Karl, OPEL Meriva, OPEL Tigra, OPEL Vectra A, OPEL Vectra B, FIAT Grande Punto, FIAT Punto Evo, DAEWOO Lanos, DAEWOO Nexia, DAEWOO Nubira, CHEVROLET Kalos, CHEVROLET Spark</p>	

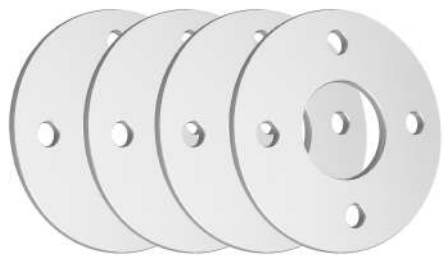
<p>Wheel flange spacers 4pcs 4x100 56,6mm 10mm Truh DFK-4x100-56,6-10-4</p>	
<p>Euro 40,90</p>	
<p>For cars: OPEL Adam, OPEL Astra F, OPEL Astra G, OPEL Astra H, OPEL Calibra, OPEL Combo, OPEL Corsa B, OPEL Corsa C, OPEL Corsa D, OPEL Corsa E, OPEL Kadet E, OPEL Karl, OPEL Meriva, OPEL Tigra, OPEL Vectra A, OPEL Vectra B, FIAT Grande Punto, FIAT Punto Evo, DAEWOO Lanos, DAEWOO Nexia, DAEWOO Nubira, CHEVROLET Kalos, CHEVROLET Spark</p>	

<p>Wheel flange spacers 2pcs 4x100 60,1mm 5mm Truh DFK-4x100-60,1-5-2</p>	
<p>Euro 18,90</p>	

For cars:

Dacia: Dacia Dokker, Dacia Lodgy, Dacia Logan MN (2 generations), Dacia Logan Pickup, Dacia Sandero (2 generations).
 Isuzu: Isuzu Gemini.

Nissan: Nissan Kubistar, Nissan Micra (2 generations), Nissan Micra K12, Nissan Note (2 generations).

Renault: Renault 19, Renault 21 4 bolts, Renault Captur, Renault Clio (4 generations), Renault Clio GrandTour, Renault Clio Kombi, Renault Grand Scenic, Renault Kangoo (2 generations), Renault Kangoo 2 4 bolts, Renault Laguna 14 bolts, Renault Megane (3 generations), Renault Megane Scenic (2 generations), Renault Modus, Renault Twingo (2 generations), Renault Wind, Renault Zoe.

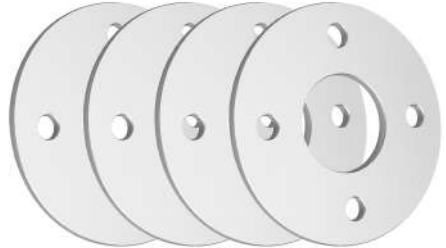
<p>Wheel flange spacers 4pcs 4x100 60,1mm 5mm Truh DFK-4x100-60,1-5-4</p>	
<p>Euro 36,90</p>	

For cars:

Dacia: Dacia Dokker, Dacia Lodgy, Dacia Logan MN (2 generations), Dacia Logan Pickup, Dacia Sandero (2 generations).
 Isuzu: Isuzu Gemini.

Nissan: Nissan Kubistar, Nissan Micra (2 generations), Nissan Micra K12, Nissan Note (2 generations).

Renault: Renault 19, Renault 21 4 bolts, Renault Captur, Renault Clio (4 generations), Renault Clio GrandTour, Renault Clio Kombi, Renault Grand Scenic, Renault Kangoo (2 generations).

generations), Renault Kangoo 2 4 bolts, Renault Laguna 14 bolts, Renault Megane (3 generations), Renault Megane Scenic (2 generations), Renault Modus, Renault Twingo (2 generations), Renault Wind, Renault Zoe.

Wheel flange spacers 2pcs 4x100 60,1mm 10mm Truh
DFK-4x100-60,1-10-2

Euro
20,90



For cars:

Dacia: Dacia Dokker, Dacia Lodgy, Dacia Logan MN (2 generations), Dacia Logan Pickup, Dacia Sandero (2 generations).

Isuzu: Isuzu Gemini.

Nissan: Nissan Kubistar, Nissan Micra (2 generations), Nissan Micra K12, Nissan Note (2 generations).

Renault: Renault 19, Renault 21 4 bolts, Renault Captur, Renault Clio (4 generations), Renault Clio GrandTour, Renault Clio Kombi, Renault Grand Scenic, Renault Kangoo (2 generations), Renault Kangoo 2 4 bolts, Renault Laguna 14 bolts, Renault Megane (3 generations), Renault Megane Scenic (2 generations), Renault Modus, Renault Twingo (2 generations), Renault Wind, Renault Zoe.

Wheel flange spacers 4pcs 4x100 60,1mm 10mm Truh
DFK-4x100-60,1-10-4

Euro
40,90

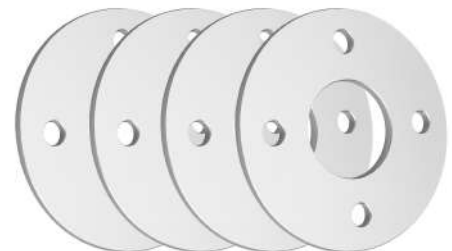

For cars:

Dacia: Dacia Dokker, Dacia Lodgy, Dacia Logan MN (2 generations), Dacia Logan Pickup, Dacia Sandero (2 generations).

Isuzu: Isuzu Gemini.

Nissan: Nissan Kubistar, Nissan Micra (2 generations), Nissan Micra K12, Nissan Note (2 generations).

Renault: Renault 19, Renault 21 4 bolts, Renault Captur, Renault Clio (4 generations), Renault Clio GrandTour, Renault Clio Kombi, Renault Grand Scenic, Renault Kangoo (2 generations), Renault Kangoo 2 4 bolts, Renault Laguna 14 bolts, Renault Megane (3 generations), Renault Megane Scenic (2 generations), Renault Modus, Renault Twingo (2 generations), Renault Wind, Renault Zoe.

Wheel flange spacers 2pcs 4x108 63,4mm 5mm Truh
DFK-4x108-63,4-5-2

Euro
21,90



For cars:

Alfa Romeo: Montreal

Ford: B-Max, Cougar, EcoSport, Escort (Gen 3-6), Escort Cosworth, Fiesta (Gen 1-2), Fiesta (Gen 3), Fiesta (Gen 4), Fiesta (Gen 5-6), Focus (Gen 1), Focus RS (Gen 1), Ka, Sport Ka, Street Ka (Gen 1), Mondeo (Gen 1), Mustang (Gen 2-3), Puma 14-inch, Puma 15-inch, Scorpio (4 boltsy, gen 2), Sierra, Sierra Cosworth, Thunderbird, Tourneo Courier

Mazda: 121, 2

Wheel flange spacers 4pcs 4x108 63,4mm 5mm Truh
DFK-4x108-63,4-5-4

Euro
43,90

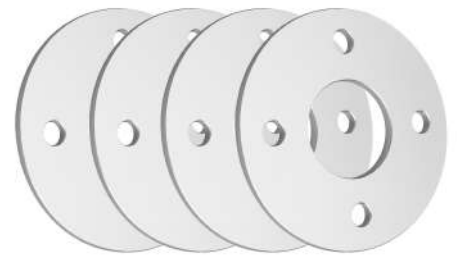

For cars:

Alfa Romeo: Montreal

Ford: B-Max, Cougar, EcoSport, Escort (Gen 3-6), Escort Cosworth, Fiesta (Gen 1-2), Fiesta (Gen 3), Fiesta (Gen 4), Fiesta (Gen 5-6), Focus (Gen 1), Focus RS (Gen 1), Ka, Sport Ka, Street Ka (Gen 1), Mondeo (Gen 1), Mustang (Gen 2-3), Puma 14-inch, Puma 15-inch, Scorpio (4 boltsy, gen 2), Sierra, Sierra Cosworth, Thunderbird, Tourneo Courier
Mazda: 121, 2

Wheel flange spacers 2pcs 4x108 63,4mm 10mm Truh
DFK-4x108-63,4-10-2



Euro
26,90

For cars:

Alfa Romeo: Montreal

Ford: B-Max, Cougar, EcoSport, Escort (Gen 3-6), Escort Cosworth, Fiesta (Gen 1-2), Fiesta (Gen 3), Fiesta (Gen 4), Fiesta (Gen 5-6), Focus (Gen 1), Focus RS (Gen 1), Ka, Sport Ka, Street Ka (Gen 1), Mondeo (Gen 1), Mustang (Gen 2-3), Puma 14-inch, Puma 15-inch, Scorpio (4 boltsy, gen 2), Sierra, Sierra Cosworth, Thunderbird, Tourneo Courier
Mazda: 121, 2

Wheel flange spacers 4pcs 4x108 63,4mm 10mm Truh
DFK-4x108-63,4-10-4



Euro
53,90

For cars:

Alfa Romeo: Montreal

Ford: B-Max, Cougar, EcoSport, Escort (Gen 3-6), Escort Cosworth, Fiesta (Gen 1-2),

Fiesta (Gen 3), Fiesta (Gen 4), Fiesta (Gen 5-6), Focus (Gen 1), Focus RS (Gen 1), Ka, Sport Ka, Street Ka (Gen 1), Mondeo (Gen 1), Mustang (Gen 2-3), Puma 14-inch, Puma 15-inch, Scorpio (4 boltsy, gen 2), Sierra, Sierra Cosworth, Thunderbird, Tourneo Courier
Mazda: 121, 2

<p>Wheel flange spacers 2pcs 4x108 65,1mm 5mm Truh DFK-4x108-65,1-5-2</p>	
<p>Euro 21,90</p>	

For cars:

Citroën: AX GTi, Berlingo (14-inch, gen 1; 15-inch, gen 1; Gen 2), BX, C2, C3, C3 Pluriel (Gen 1-2), C3 Picasso (mini MPV), C4 (Gen 1-2), C4 Cactus (compact SUV), C4 Picasso, Grand Picasso (compact MPV, gen 1), C5 (Gen 1), DS 3, DS 4, DS 5, Saxo, Xantia, Xsara, Xsara Picasso, ZX.

Peugeot: 1007, 106, 2008, 205, 206, 206 cab, 206 SW, 207, 207 cab, 207 SW, 208, 208 GTI, 3008, 306, 307, 307 cab, 307 SW, 308 (Gen 1, T7), 309, 405, 406, 406 Coupé, 5008, Partner (Gen 1), Partner Tepee (Gen 2).

Saab: 900, 9000.

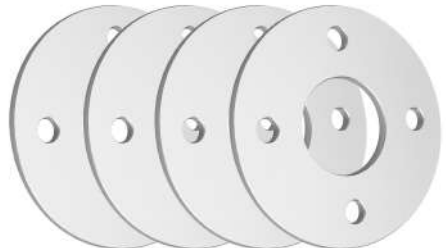
<p>Wheel flange spacers 4pcs 4x108 65,1mm 5mm Truh DFK-4x108-65,1-5-4</p>	
<p>Euro 43,90</p>	

For cars:

Citroën: AX GTi, Berlingo (14-inch, gen 1; 15-inch, gen 1; Gen 2), BX, C2, C3, C3 Pluriel (Gen 1-2), C3 Picasso (mini MPV), C4 (Gen 1-2), C4 Cactus (compact SUV), C4 Picasso, Grand Picasso (compact MPV, gen 1), C5 (Gen 1), DS 3, DS 4, DS 5, Saxo, Xantia, Xsara,

Xsara Picasso, ZX.

Peugeot: 1007, 106, 2008, 205, 206, 206 cab, 206 SW, 207, 207 cab, 207 SW, 208, 208 GTI, 3008, 306, 307, 307 cab, 307 SW, 308 (Gen 1, T7), 309, 405, 406, 406 Coupé, 5008, Partner (Gen 1), Partner Tepee (Gen 2).

Saab: 900, 9000.

Wheel flange spacers 2pcs 4x108 65,1mm 10mm Truh
DFK-4x108-65,1-10-2



Euro
26,90

For cars:

Citroën: AX GTi, Berlingo (14-inch, gen 1; 15-inch, gen 1; Gen 2), BX, C2, C3, C3 Pluriel (Gen 1-2), C3 Picasso (mini MPV), C4 (Gen 1-2), C4 Cactus (compact SUV), C4 Picasso, Grand Picasso (compact MPV, gen 1), C5 (Gen 1), DS 3, DS 4, DS 5, Saxo, Xantia, Xsara, Xsara Picasso, ZX.

Peugeot: 1007, 106, 2008, 205, 206, 206 cab, 206 SW, 207, 207 cab, 207 SW, 208, 208 GTI, 3008, 306, 307, 307 cab, 307 SW, 308 (Gen 1, T7), 309, 405, 406, 406 Coupé, 5008, Partner (Gen 1), Partner Tepee (Gen 2).

Saab: 900, 9000.

Wheel flange spacers 4pcs 4x108 65,1mm 10mm Truh
DFK-4x108-65,1-10-4

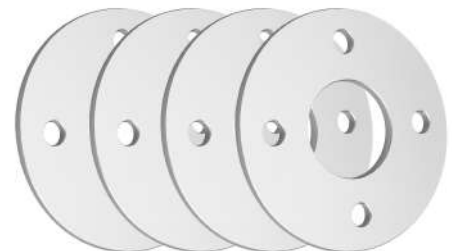

Euro
53,90

For cars:

Citroën: AX GTi, Berlingo (14-inch, gen 1; 15-inch, gen 1; Gen 2), BX, C2, C3, C3 Pluriel (Gen 1-2), C3 Picasso (mini MPV), C4 (Gen 1-2), C4 Cactus (compact SUV), C4 Picasso,

Grand Picasso (compact MPV, gen 1), C5 (Gen 1), DS 3, DS 4, DS 5, Saxo, Xantia, Xsara, Xsara Picasso, ZX.

Peugeot: 1007, 106, 2008, 205, 206, 206 cab, 206 SW, 207, 207 cab, 207 SW, 208, 208 GTI, 3008, 306, 307, 307 cab, 307 SW, 308 (Gen 1, T7), 309, 405, 406, 406 Coupé, 5008, Partner (Gen 1), Partner Tepee (Gen 2).

Saab: 900, 9000.

Wheel flange spacers 2pcs 5x112 57,1mm 5mm Truh
DFK-5x112-57,1-5-2



Euro
18,90

For cars: Audi A3, Audi A4, Audi A6, Audi A8, Audi TT, Ford Galaxy, Seat Alhambra, Seat Altea, Seat Ateca, Seat Leon, Seat Exeo, Seat Toledo, Skoda Octavia, Skoda Superb, Skoda Yeti, VW T4, VW Golf V, VW Golf VI, VW Golf VII, VW Jetta, VW Eos, VW Caddy, VW Passat, VW Touran, VW Tiguan, VW Transporter T4, VW Phaeton, VW Sharan, VW Lupo, VW Polo, VW Scirocco, VW Up, VW Vento

Wheel flange spacers 4pcs 5x112 57,1mm 5mm Truh
DFK-5x112-57,1-5-4





Euro
34,90

For cars: Audi A3, Audi A4, Audi A6, Audi A8, Audi TT, Ford Galaxy, Seat Alhambra, Seat Altea, Seat Ateca, Seat Leon, Seat Exeo, Seat Toledo, Skoda Octavia, Skoda Superb, Skoda Yeti, VW T4, VW Golf V, VW Golf VI, VW Golf VII, VW Jetta, VW Eos, VW Caddy, VW Passat, VW Touran, VW Tiguan, VW Transporter T4, VW Phaeton, VW Sharan, VW Lupo, VW Polo, VW Scirocco, VW Up, VW Vento

<p>Wheel flange spacers 2pcs 5x112 57,1mm 10mm Truh DFK-5x112-57,1-10-2</p>	
<p>Euro 22,90</p>	
<p>For cars: Audi A3, Audi A4, Audi A6, Audi A8, Audi TT, Ford Galaxy, Seat Alhambra, Seat Altea, Seat Ateca, Seat Leon, Seat Exeo, Seat Toledo, Skoda Octavia, Skoda Superb, Skoda Yeti, VW T4, VW Golf V, VW Golf VI, VW Golf VII, VW Jetta, VW Eos, VW Caddy, VW Passat, VW Touran, VW Tiguan, VW Transporter T4, VW Phaeton, VW Sharan, VW Lupo, VW Polo, VW Scirocco, VW Up, VW Vento</p>	

<p>Wheel flange spacers 4pcs 5x112 57,1mm 10mm Truh DFK-5x112-57,1-10-4</p>	
<p>Euro 44,90</p>	
<p>For cars: Audi A3, Audi A4, Audi A6, Audi A8, Audi TT, Ford Galaxy, Seat Alhambra, Seat Altea, Seat Ateca, Seat Leon, Seat Exeo, Seat Toledo, Skoda Octavia, Skoda Superb, Skoda Yeti, VW T4, VW Golf V, VW Golf VI, VW Golf VII, VW Jetta, VW Eos, VW Caddy, VW Passat, VW Touran, VW Tiguan, VW Transporter T4, VW Phaeton, VW Sharan, VW Lupo, VW Polo, VW Scirocco, VW Up, VW Vento</p>	

<p>Wheel flange spacers 2pcs 5x100 54,1mm 5mm Truh DFK-5x100-54,1-5-2</p>	
<p>Euro 18,90</p>	
<p>For cars: Lexus: CT 200h (A10). Subaru: Trezia. Toyota: Avensis (T220, T250), Camry, Carina (T170), Carina (T190), Celica (T160), Celica (T180), Celica (T200, T230), iQ (AJ10), Prius (XW20, XW30, XW50), Urban Cruiser (XP110), Verso-S (NCP120).</p>	

<p>Wheel flange spacers 4pcs 5x100 54,1mm 5mm Truh DFK-5x100-54,1-5-4</p>	
<p>Euro 37,90</p>	
<p>For cars: Lexus: CT 200h (A10). Subaru: Trezia. Toyota: Avensis (T220, T250), Camry, Carina (T170), Carina (T190), Celica (T160), Celica (T180), Celica (T200, T230), iQ (AJ10), Prius (XW20, XW30, XW50), Urban Cruiser (XP110), Verso-S (NCP120).</p>	

<p>Wheel flange spacers 2pcs 5x100 54,1mm 10mm Truh DFK-5x100-54,1-10-2</p>	
<p>Euro 21,90</p>	
<p>For cars: Lexus: CT 200h (A10). Subaru: Trezia. Toyota: Avensis (T220, T250), Camry, Carina (T170), Carina (T190), Celica (T160), Celica (T180), Celica (T200, T230), iQ (AJ10), Prius (XW20, XW30, XW50), Urban Cruiser (XP110), Verso-S (NCP120).</p>	

<p>Wheel flange spacers 4pcs 5x100 54,1mm 10mm Truh DFK-5x100-54,1-10-4</p>	
<p>Euro 43,90</p>	
<p>For cars: Lexus: CT 200h (A10). Subaru: Trezia. Toyota: Avensis (T220, T250), Camry, Carina (T170), Carina (T190), Celica (T160), Celica (T180), Celica (T200, T230), iQ (AJ10), Prius (XW20, XW30, XW50), Urban Cruiser (XP110), Verso-S (NCP120).</p>	

<p>Wheel flange spacers 2pcs 5x100 56,1mm 5mm Truh DFK-5x100-56,1-5-2</p>	
<p>Euro 18,90</p>	
<p style="text-align: center;">For cars: Subaru: Baja, BRZ, Forester (SF, SFS; SG, SGS; SH; SJ; S5), Impreza (GF, GFC, GC; GG; GD; GR; G3), Legacy (BJF, BD, BG; BE, BH, BL, BP; BM, BR), Outback (BP; BM, BR), XV (G4; GT). Toyota: GT 86.</p>	

<p>Wheel flange spacers 4pcs 5x100 56,1mm 5mm Truh DFK-5x100-56,1-5-4</p>	
<p>Euro 37,90</p>	
<p style="text-align: center;">For cars: Subaru: Baja, BRZ, Forester (SF, SFS; SG, SGS; SH; SJ; S5), Impreza (GF, GFC, GC; GG; GD; GR; G3), Legacy (BJF, BD, BG; BE, BH, BL, BP; BM, BR), Outback (BP; BM, BR), XV (G4; GT). Toyota: GT 86.</p>	

<p>Wheel flange spacers 2pcs 5x100 56,1mm 10mm Truh DFK-5x100-56,1-10-2</p>	
<p>Euro 21,90</p>	
<p style="text-align: center;">For cars: Subaru: Baja, BRZ, Forester (SF, SFS; SG, SGS; SH; SJ; S5), Impreza (GF, GFC, GC; GG; GD; GR; G3), Legacy (BJF, BD, BG; BE, BH, BL, BP; BM, BR), Outback (BP; BM, BR), XV (G4; GT). Toyota: GT 86.</p>	

<p>Wheel flange spacers 4pcs 5x100 56,1mm 10mm Truh DFK-5x100-56,1-10-4</p>	
<p>Euro 43,90</p>	
<p style="text-align: center;">For cars: Subaru: Baja, BRZ, Forester (SF, SFS; SG, SGS; SH; SJ; S5), Impreza (GF, GFC, GC; GG; GD; GR; G3), Legacy (BJF, BD, BG; BE, BH, BL, BP; BM, BR), Outback (BP; BM, BR), XV (G4; GT). Toyota: GT 86.</p>	

<p>Wheel flange spacers 2pcs 5x100 57,1mm 5mm Truh DFK-5x100-57,1-5-2</p>	
<p>Euro 18,90</p>	
<p>For cars: Audi: A1, A2, A3 8L, S3 8L, TT 8N. Seat: Cordoba III, Ibiza IV V, Leon I, Toledo II. Skoda: Fabia I II III, Octavia I, Praktik, Rapid, Roomster. VW: Bora, Fox, Golf III IV, Beetle, Passat B3 B4, Polo IV V, Vento VR6.</p>	

<p>Wheel flange spacers 4pcs 5x100 57,1mm 5mm Truh DFK-5x100-57,1-5-4</p>	
<p>Euro 37,90</p>	
<p>For cars: Audi: A1, A2, A3 8L, S3 8L, TT 8N. Seat: Cordoba III, Ibiza IV V, Leon I, Toledo II. Skoda: Fabia I II III, Octavia I, Praktik, Rapid, Roomster. VW: Bora, Fox, Golf III IV, Beetle, Passat B3 B4, Polo IV V, Vento VR6.</p>	

<p>Wheel flange spacers 2pcs 5x100 57,1mm 10mm Truh DFK-5x100-57,1-10-2</p>	
<p>Euro 21,90</p>	
<p>For cars: Audi: A1, A2, A3 8L, S3 8L, TT 8N. Seat: Cordoba III, Ibiza IV V, Leon I, Toledo II. Skoda: Fabia I II III, Octavia I, Praktik, Rapid, Roomster. VW: Bora, Fox, Golf III IV, Beetle, Passat B3 B4, Polo IV V, Vento VR6.</p>	

<p>Wheel flange spacers 4pcs 5x100 57,1mm 10mm Truh DFK-5x100-57,1-10-4</p>	
<p>Euro 43,90</p>	
<p>For cars: Audi: A1, A2, A3 8L, S3 8L, TT 8N. Seat: Cordoba III, Ibiza IV V, Leon I, Toledo II. Skoda: Fabia I II III, Octavia I, Praktik, Rapid, Roomster. VW: Bora, Fox, Golf III IV, Beetle, Passat B3 B4, Polo IV V, Vento VR6.</p>	

<p>Wheel flange spacers 2pcs 5x108 63,3mm 5mm Truh DFK-5x108-63,3-5-2</p>	
<p>Euro 18,90</p>	
<p style="text-align: center;">For cars:</p> <p>Ford: C-MAX, Edge, Escape, Focus, Focus C-Max, Galaxy, Grand C-Max, Kuga, Mondeo MK3 MK4 MK5, S-Max, Taurus, Transit Connect, Windstar. Jaguar: E-Pace, F-Pace, F-Type, I-Pace, S-Type, X-Type, XE, XF, XJ, XK. Land Rover: Evoque, Freelander II. Volvo: C30, C70, S40, S60, S80, S90, V40, V50, V60, V70, V90, XC40, XC60, XC70, XC90.</p>	

<p>Wheel flange spacers 4pcs 5x108 63,3mm 5mm Truh DFK-5x108-63,3-5-4</p>	
<p>Euro 36,90</p>	
<p style="text-align: center;">For cars:</p> <p>Ford: C-MAX, Edge, Escape, Focus, Focus C-Max, Galaxy, Grand C-Max, Kuga, Mondeo MK3 MK4 MK5, S-Max, Taurus, Transit Connect, Windstar. Jaguar: E-Pace, F-Pace, F-Type, I-Pace, S-Type, X-Type, XE, XF, XJ, XK. Land Rover: Evoque, Freelander II. Volvo: C30, C70, S40, S60, S80, S90, V40, V50, V60, V70, V90, XC40, XC60, XC70, XC90.</p>	

<p>Wheel flange spacers 2pcs 5x108 63,3mm 10mm Truh DFK-5x108-63,3-10-2</p>	
<p>Euro 22,90</p>	
<p style="text-align: center;">For cars:</p> <p>Ford: C-MAX, Edge, Escape, Focus, Focus C-Max, Galaxy, Grand C-Max, Kuga, Mondeo MK3 MK4 MK5, S-Max, Taurus, Transit Connect, Windstar. Jaguar: E-Pace, F-Pace, F-Type, I-Pace, S-Type, X-Type, XE, XF, XJ, XK. Land Rover: Evoque, Freelander II. Volvo: C30, C70, S40, S60, S80, S90, V40, V50, V60, V70, V90, XC40, XC60, XC70, XC90.</p>	

<p>Wheel flange spacers 4pcs 5x108 63,3mm 10mm Truh DFK-5x108-63,3-10-4</p>	
<p>Euro 44,90</p>	
<p style="text-align: center;">For cars:</p> <p>Ford: C-MAX, Edge, Escape, Focus, Focus C-Max, Galaxy, Grand C-Max, Kuga, Mondeo MK3 MK4 MK5, S-Max, Taurus, Transit Connect, Windstar. Jaguar: E-Pace, F-Pace, F-Type, I-Pace, S-Type, X-Type, XE, XF, XJ, XK. Land Rover: Evoque, Freelander II. Volvo: C30, C70, S40, S60, S80, S90, V40, V50, V60, V70, V90, XC40, XC60, XC70, XC90.</p>	

<p>Wheel flange spacers 2pcs 5x108 65,1mm 5mm Truh DFK-5x108-65,1-5-2</p>	
<p>Euro 18,90</p>	
<p>For cars: Citroen: C5, C6, Jumpy, XM. Peugeot: 407, 407 coupe, 407 SW, 508, 5008, 605, 607, Expert II, RCZ. Volvo: 740, 760, 850, 940, 960, C30, C70, S40, S60, S70, V70, S80, S90, V90, XC70, XC90.</p>	

<p>Wheel flange spacers 4pcs 5x108 65,1mm 5mm Truh DFK-5x108-65,1-5-4</p>	
<p>Euro 36,90</p>	
<p>For cars: Citroen: C5, C6, Jumpy, XM. Peugeot: 407, 407 coupe, 407 SW, 508, 5008, 605, 607, Expert II, RCZ. Volvo: 740, 760, 850, 940, 960, C30, C70, S40, S60, S70, V70, S80, S90, V90, XC70, XC90.</p>	

<p>Wheel flange spacers 2pcs 5x108 65,1mm 10mm Truh DFK-5x108-65,1-10-2</p>	
<p>Euro 22,90</p>	
<p>For cars: Citroen: C5, C6, Jumpy, XM. Peugeot: 407, 407 coupe, 407 SW, 508, 5008, 605, 607, Expert II, RCZ. Volvo: 740, 760, 850, 940, 960, C30, C70, S40, S60, S70, V70, S80, S90, V90, XC70, XC90.</p>	

<p>Wheel flange spacers 4pcs 5x108 65,1mm 10mm Truh DFK-5x108-65,1-10-4</p>	
<p>Euro 44,90</p>	
<p>For cars: Citroen: C5, C6, Jumpy, XM. Peugeot: 407, 407 coupe, 407 SW, 508, 5008, 605, 607, Expert II, RCZ. Volvo: 740, 760, 850, 940, 960, C30, C70, S40, S60, S70, V70, S80, S90, V90, XC70, XC90.</p>	

<p>Wheel flange spacers 2pcs 5x110 65,1mm 5mm Truh DFK-5x110-65,1-5-2</p>	
<p>Euro 21,90</p>	
<p style="text-align: center;">For cars: Alfa Romeo: 159, Brera, Giulia, Giulietta, Spider. Chevrolet: HHR, Malibu. Fiat: 500X, Croma (2 generations). Opel/Vauxhall: Adam 5, Astra 6, Astra H, Calibra A (V6 and Turbo), Combo, Corsa C, Corsa D, Corsa D OPC, GT convertible, Meriva (2 generations plus OPC), Omega A, Omega B, Signum, Vectra A, Vectra B, Vectra C, Vectra C OPC, Zafira (2 generations plus OPC). Pontiac: 65, G6, Solstice. Saab: 9-3 (2 generations plus 9-3X), 9-5 (2 generations), 900.</p>	

<p>Wheel flange spacers 4pcs 5x110 65,1mm 5mm Truh DFK-5x110-65,1-5-4</p>	
<p>Euro 44,90</p>	
<p style="text-align: center;">For cars: Alfa Romeo: 159, Brera, Giulia, Giulietta, Spider. Chevrolet: HHR, Malibu. Fiat: 500X, Croma (2 generations). Opel/Vauxhall: Adam 5, Astra 6, Astra H, Calibra A (V6 and Turbo), Combo, Corsa C, Corsa D, Corsa D OPC, GT convertible, Meriva (2 generations plus OPC), Omega A, Omega B, Signum, Vectra A, Vectra B, Vectra C, Vectra C OPC, Zafira (2 generations plus OPC). Pontiac: 65, G6, Solstice. Saab: 9-3 (2 generations plus 9-3X), 9-5 (2 generations), 900.</p>	

<p>Wheel flange spacers 2pcs 5x110 65,1mm 10mm Truh DFK-5x110-65,1-10-2</p>	
<p>Euro 26,90</p>	
<p style="text-align: center;">For cars: Alfa Romeo: 159, Brera, Giulia, Giulietta, Spider. Chevrolet: HHR, Malibu. Fiat: 500X, Croma (2 generations). Opel/Vauxhall: Adam 5, Astra 6, Astra H, Calibra A (V6 and Turbo), Combo, Corsa C, Corsa D, Corsa D OPC, GT convertible, Meriva (2 generations plus OPC), Omega A, Omega B, Signum, Vectra A, Vectra B, Vectra C, Vectra C OPC, Zafira (2 generations plus OPC). Pontiac: 65, G6, Solstice. Saab: 9-3 (2 generations plus 9-3X), 9-5 (2 generations), 900.</p>	

<p>Wheel flange spacers 4pcs 5x110 65,1mm 10mm Truh DFK-5x110-65,1-10-4</p>	
<p>Euro 53,90</p>	
<p style="text-align: center;">For cars: Alfa Romeo: 159, Brera, Giulia, Giulietta, Spider. Chevrolet: HHR, Malibu. Fiat: 500X, Croma (2 generations). Opel/Vauxhall: Adam 5, Astra 6, Astra H, Calibra A (V6 and Turbo), Combo, Corsa C, Corsa D, Corsa D OPC, GT convertible, Meriva (2 generations plus OPC), Omega A, Omega B, Signum, Vectra A, Vectra B, Vectra C, Vectra C OPC, Zafira (2 generations plus OPC). Pontiac: 65, G6, Solstice. Saab: 9-3 (2 generations plus 9-3X), 9-5 (2 generations), 900.</p>	

<p>Wheel flange spacers 2pcs 5x112 66,6mm 5mm Truh DFK-5x112-66,6-5-2</p>	
<p>Euro 18,90</p>	
<p>For cars: MERCEDES A W168 W169 W176 W177, MERCEDES B W245 W246, MERCEDES C W202 W203 W204 W205, MERCEDES CL W215 W216, MERCEDES CLA, MERCEDES CLC, MERCEDES CLK W208 W209, MERCEDES CLS W218 W219, MERCEDES E C207 R207 W123 W124 W210 W211 W212, MERCEDES GL X164, MERCEDES GLA, MERCEDES GLC, MERCEDES GLE, MERCEDES GLE Coupe, MERCEDES GLK X204, MERCEDES M W163 W164 W166, MERCEDES R W251, MERCEDES S W126 W140 W220 W221 W222, MERCEDES SL R129 R230 R231 W107, MERCEDES SLK R170 R171 R172, MERCEDES Vaneo W414, MERCEDES Viano W639, MERCEDES Vito W638 W369 W447, MERCEDES V W638 W447, BMW 2, BMW 5 G31, BMW 6 G32, BMW 7 G11, BMW 7 G12, BMW i3, BMW i8, BMW X1 F48, BMW X3 G01, AUDI A4 B8 B9, AUDI A5, AUDI A5 Sportback, AUDI A6, AUDI A7, AUDI Q5, AUDI Q7, MINI Cooper, MINI One, SSANG YONG Korando, SSANG YONG Tivoli, VOLKSWAGEN Transporter T2 T3, PORSCHE Macan, CHRYSLER Crossfire</p>	

<p>Wheel flange spacers 4pcs 5x112 66,6mm 5mm Truh DFK-5x112-66,6-5-4</p>	
<p>Euro 36,90</p>	
<p>For cars: MERCEDES A W168 W169 W176 W177, MERCEDES B W245 W246, MERCEDES C W202 W203 W204 W205, MERCEDES CL W215 W216, MERCEDES CLA, MERCEDES CLC, MERCEDES CLK W208 W209, MERCEDES CLS W218 W219, MERCEDES E C207 R207 W123 W124 W210 W211 W212, MERCEDES GL X164, MERCEDES GLA, MERCEDES GLC, MERCEDES GLE, MERCEDES GLE Coupe, MERCEDES GLK X204, MERCEDES M W163 W164 W166, MERCEDES R W251,</p>	

MERCEDES S W126 W140 W220 W221 W222, MERCEDES SL R129 R230 R231 W107, MERCEDES SLK R170 R171 R172, MERCEDES Vaneo W414, MERCEDES Viano W639, MERCEDES Vito W638 W369 W447, MERCEDES V W638 W447, BMW 2, BMW 5 G31, BMW 6 G32, BMW 7 G11, BMW 7 G12, BMW i3, BMW i8, BMW X1 F48, BMW X3 G01, AUDI A4 B8 B9, AUDI A5, AUDI A5 Sportback, AUDI A6, AUDI A7, AUDI Q5, AUDI Q7, MINI Cooper, MINI One, SSANG YONG Korando, SSANG YONG Tivoli, VOLKSWAGEN Transporter T2 T3, PORSCHE Macan, CHRYSLER Crossfire

Wheel flange spacers 2pcs 5x112 66,6mm 10mm Truh
DFK-5x112-66,6-10-2



Euro
22,90

For cars: MERCEDES A W168 W169 W176 W177, MERCEDES B W245 W246, MERCEDES C W202 W203 W204 W205, MERCEDES CL W215 W216, MERCEDES CLA, MERCEDES CLC, MERCEDES CLK W208 W209, MERCEDES CLS W218 W219, MERCEDES E C207 R207 W123 W124 W210 W211 W212, MERCEDES GL X164, MERCEDES GLA, MERCEDES GLC, MERCEDES GLE, MERCEDES GLE Coupe, MERCEDES GLK X204, MERCEDES M W163 W164 W166, MERCEDES R W251, MERCEDES S W126 W140 W220 W221 W222, MERCEDES SL R129 R230 R231 W107, MERCEDES SLK R170 R171 R172, MERCEDES Vaneo W414, MERCEDES Viano W639, MERCEDES Vito W638 W369 W447, MERCEDES V W638 W447, BMW 2, BMW 5 G31, BMW 6 G32, BMW 7 G11, BMW 7 G12, BMW i3, BMW i8, BMW X1 F48, BMW X3 G01, AUDI A4 B8 B9, AUDI A5, AUDI A5 Sportback, AUDI A6, AUDI A7, AUDI Q5, AUDI Q7, MINI Cooper, MINI One, SSANG YONG Korando, SSANG YONG Tivoli, VOLKSWAGEN Transporter T2 T3, PORSCHE Macan, CHRYSLER Crossfire

<p>Wheel flange spacers 4pcs 5x112 66,6mm 10mm Truh DFK-5x112-66,6-10-4</p>	
<p>Euro 44,90</p>	
<p>For cars: MERCEDES A W168 W169 W176 W177, MERCEDES B W245 W246, MERCEDES C W202 W203 W204 W205, MERCEDES CL W215 W216, MERCEDES CLA, MERCEDES CLC, MERCEDES CLK W208 W209, MERCEDES CLS W218 W219, MERCEDES E C207 R207 W123 W124 W210 W211 W212, MERCEDES GL X164, MERCEDES GLA, MERCEDES GLC, MERCEDES GLE, MERCEDES GLE Coupe, MERCEDES GLK X204, MERCEDES M W163 W164 W166, MERCEDES R W251, MERCEDES S W126 W140 W220 W221 W222, MERCEDES SL R129 R230 R231 W107, MERCEDES SLK R170 R171 R172, MERCEDES Vaneo W414, MERCEDES Viano W639, MERCEDES Vito W638 W369 W447, MERCEDES V W638 W447, BMW 2, BMW 5 G31, BMW 6 G32, BMW 7 G11, BMW 7 G12, BMW i3, BMW i8, BMW X1 F48, BMW X3 G01, AUDI A4 B8 B9, AUDI A5, AUDI A5 Sportback, AUDI A6, AUDI A7, AUDI Q5, AUDI Q7, MINI Cooper, MINI One, SSANG YONG Korando, SSANG YONG Tivoli, VOLKSWAGEN Transporter T2 T3, PORSCHE Macan, CHRYSLER Crossfire</p>	

<p>Wheel flange spacers 2pcs 5x114,3 66,1mm 5mm Truh DFK-5x114,3-66,1-5-2</p>	
<p>Euro 19,90</p>	
<p>For cars: Dacia: Duster. Fiat: Talento. Infiniti: ESQ I4, EX, G, I, J30, JX35, M, Q40, Q45, Q50, Q60, Q70, QX50, QX60, QX70. Nissan: 200SX, 300ZX, 350Z, Almera T, Altima, Cefiro, Dualis (w tym Dualis I4 1.6 dCi 2013-2013, Dualis I4 2.0i 2007-2013, Dualis I4 2.0i (DBA-J10) 2007-2009), e-NV200,</p>	

Elgrand, Fairlady Z, GT-R, Juke, Lannia, Leaf, Maxima, Murano, NV200, NV300, Pathfinder, Presage, President, Primera, Pulsar, Qashqai, Quest, Rogue, Sentra, Serena, Sylphy, Teana, Terrano, Tiida, X-Trail.

Opel: Vivaro.

Renault: Arkana, Captur, Duster, Espace, Fluence, Grand Scenic, Kadjar, Kaptur, Koleos, Laguna, Latitude, Megane, Safrane, Scenic, Talisman, Trafic, ZOE.

Wheel flange spacers 4pcs 5x114,3 66,1mm 5mm Truh
DFK-5x114,3-66,1-5-4



Euro
39,90

For cars:

Dacia: Duster.

Fiat: Talento.

Infiniti: ESQ I4, EX, G, I, J30, JX35, M, Q40, Q45, Q50, Q60, Q70, QX50, QX60, QX70.

Nissan: 200SX, 300ZX, 350Z, Almera T, Altima, Cefiro, Dualis (w tym Dualis I4 1.6 dCi 2013-2013, Dualis I4 2.0i 2007-2013, Dualis I4 2.0i (DBA-J10) 2007-2009), e-NV200,

Elgrand, Fairlady Z, GT-R, Juke, Lannia, Leaf, Maxima, Murano, NV200, NV300, Pathfinder, Presage, President, Primera, Pulsar, Qashqai, Quest, Rogue, Sentra, Serena, Sylphy, Teana, Terrano, Tiida, X-Trail.

Opel: Vivaro.

Renault: Arkana, Captur, Duster, Espace, Fluence, Grand Scenic, Kadjar, Kaptur, Koleos, Laguna, Latitude, Megane, Safrane, Scenic, Talisman, Trafic, ZOE.

<p>Wheel flange spacers 2pcs 5x114,3 66,1mm 10mm Truh DFK-5x114,3-66,1-10-2</p>	
<p>Euro 26,90</p>	
<p>For cars: Dacia: Duster. Fiat: Talento. Infiniti: ESQ I4, EX, G, I, J30, JX35, M, Q40, Q45, Q50, Q60, Q70, QX50, QX60, QX70. Nissan: 200SX, 300ZX, 350Z, Almera T, Altima, Cefiro, Dualis (w tym Dualis I4 1.6 dCi 2013-2013, Dualis I4 2.0i 2007-2013, Dualis I4 2.0i (DBA-J10) 2007-2009), e-NV200, Elgrand, Fairlady Z, GT-R, Juke, Lannia, Leaf, Maxima, Murano, NV200, NV300, Pathfinder, Presage, President, Primera, Pulsar, Qashqai, Quest, Rogue, Sentra, Serena, Sylphy, Teana, Terrano, Tiida, X-Trail. Opel: Vivaro. Renault: Arkana, Captur, Duster, Espace, Fluence, Grand Scenic, Kadjar, Kaptur, Koleos, Laguna, Latitude, Megane, Safrane, Scenic, Talisman, Trafic, ZOE.</p>	

<p>Wheel flange spacers 4pcs 5x114,3 66,1mm 10mm Truh DFK-5x114,3-66,1-10-4</p>	
<p>Euro 53,90</p>	
<p>For cars: Dacia: Duster. Fiat: Talento. Infiniti: ESQ I4, EX, G, I, J30, JX35, M, Q40, Q45, Q50, Q60, Q70, QX50, QX60, QX70. Nissan: 200SX, 300ZX, 350Z, Almera T, Altima, Cefiro, Dualis (w tym Dualis I4 1.6 dCi 2013-2013, Dualis I4 2.0i 2007-2013, Dualis I4 2.0i (DBA-J10) 2007-2009), e-NV200, Elgrand, Fairlady Z, GT-R, Juke, Lannia, Leaf, Maxima, Murano, NV200, NV300,</p>	

Pathfinder, Presage, President, Primera, Pulsar, Qashqai, Quest, Rogue, Sentra, Serena, Sylphy, Teana, Terrano, Tiida, X-Trail.

Opel: Vivaro.

Renault: Arkana, Captur, Duster, Espace, Fluence, Grand Scenic, Kadjar, Kaptur, Koleos, Laguna, Latitude, Megane, Safrane, Scenic, Talisman, Trafic, ZOE.

Wheel flange spacers 2pcs 5x114,3 67mm 5mm Truh
DFK-5x114,3-67-5-2



Euro
19,90

For cars:

Citroen: C4 Aircross, C-Crosser.

Dodge: Avenger, Caliber.

Hyundai: Coupe, Genesis, Grandeur, i30, i40, Ioniq, ix20, ix35, ix55, Kona, Santa Fe, Sonata, Trajet, Tucson, Veloster, XG.

Jeep: Compass (to 2017), Patriot.

Kia: Amanti (to 2006), Carens (since 2006), Carnival (since 2006), Ceed, Magentis (since 2005), Niro, Opirus, Optima (since 2005), Pro Ceed, Sorento (since 2009), Soul, Sportage (since 2004), Venga.

Mazda: 3, 5, 6, 323 (5 bolts), 626 (5 bolts), CX-3, CX-5, CX-7, CX-9, MPV, MX-5 (since 2005), MX-6, Premacy, RX-7 (5 bolts), RX-8, Tribute, Xedos 6, Xedos 9.

Mitsubishi: ASX, Eclipse, Lancer (5 bolts), Outlander, Pajero Pinin, Space Wagon (1999-2004).

Peugeot: 4007, 4008.

<p>Wheel flange spacers 4pcs 5x114,3 67mm 5mm Truh DFK-5x114,3-67-5-4</p>	
<p>Euro 39,90</p>	
<p style="text-align: center;">For cars:</p> <p style="text-align: center;">Citroen: C4 Aircross, C-Crosser. Dodge: Avenger, Caliber. Hyundai: Coupe, Genesis, Grandeur, i30, i40, Ioniq, ix20, ix35, ix55, Kona, Santa Fe, Sonata, Trajet, Tucson, Veloster, XG. Jeep: Compass (to 2017), Patriot. Kia: Amanti (to 2006), Carens (since 2006), Carnival (since 2006), Ceed, Magentis (since 2005), Niro, Opirus, Optima (since 2005), Pro Ceed, Sorento (since 2009), Soul, Sportage (since 2004), Venga. Mazda: 3, 5, 6, 323 (5 bolts), 626 (5 bolts), CX-3, CX-5, CX-7, CX-9, MPV, MX-5 (since 2005), MX-6, Premacy, RX-7 (5 bolts), RX-8, Tribute, Xedos 6, Xedos 9. Mitsubishi: ASX, Eclipse, Lancer (5 bolts), Outlander, Pajero Pinin, Space Wagon (1999-2004). Peugeot: 4007, 4008.</p>	

<p>Wheel flange spacers 2pcs 5x114,3 67mm 10mm Truh DFK-5x114,3-67-10-2</p>	
<p>Euro 28,90</p>	
<p style="text-align: center;">For cars:</p> <p style="text-align: center;">Citroen: C4 Aircross, C-Crosser. Dodge: Avenger, Caliber. Hyundai: Coupe, Genesis, Grandeur, i30, i40, Ioniq, ix20, ix35, ix55, Kona, Santa Fe, Sonata, Trajet, Tucson, Veloster, XG.</p>	

Jeep: Compass (do 2017), Patriot.

Kia: Amanti (do 2006), Carens (od 2006), Carnival (od 2006), Ceed, Magentis (od 2005), Niro, Opirus, Optima (od 2005), Pro Ceed, Sorento (od 2009), Soul, Sportage (od 2004), Venga.

Mazda: 3, 5, 6, 323 (5 bolts), 626 (5 bolts), CX-3, CX-5, CX-7, CX-9, MPV, MX-5 (od 2005), MX-6, Premacy, RX-7 (5 bolts), RX-8, Tribute, Xedos 6, Xedos 9.

Mitsubishi: ASX, Eclipse, Lancer (5 bolts), Outlander, Pajero Pinin, Space Wagon (1999-2004).

Peugeot: 4007, 4008.

Wheel flange spacers 4pcs 5x114,3 67mm 10mm Truh
DFK-5x114,3-67-10-4

Euro
56,90



For cars:

Citroen: C4 Aircross, C-Crosser.

Dodge: Avenger, Caliber.

Hyundai: Coupe, Genesis, Grandeur, i30, i40, Ioniq, ix20, ix35, ix55, Kona, Santa Fe, Sonata, Trajet, Tucson, Veloster, XG.

Jeep: Compass (do 2017), Patriot.

Kia: Amanti (do 2006), Carens (od 2006), Carnival (od 2006), Ceed, Magentis (od 2005), Niro, Opirus, Optima (od 2005), Pro Ceed, Sorento (od 2009), Soul, Sportage (od 2004), Venga.

Mazda: 3, 5, 6, 323 (5 bolts), 626 (5 bolts), CX-3, CX-5, CX-7, CX-9, MPV, MX-5 (od 2005), MX-6, Premacy, RX-7 (5 bolts), RX-8, Tribute, Xedos 6, Xedos 9.

Mitsubishi: ASX, Eclipse, Lancer (5 bolts), Outlander, Pajero Pinin, Space Wagon (1999-2004).

Peugeot: 4007, 4008.